

Elmira Stove Works

ANTIQUE APPLIANCE
BUYER'S GUIDE



RANGES | REFRIGERATORS | WALL OVENS | MICROWAVES | DISHWASHER PANELS





It's all in the details.

Each and every Elmira appliance is handcrafted by experienced staff in our factory in Elmira, Ontario, Canada. Careful engineering, meticulous attention to detail, and rigorous inspection – from the first bolt to final testing, polishing and packaging – set Elmira appliances apart from any others.

Show your kitchen some love.

Imagine the warmth and charm of Elmira's vintage-inspired Antique appliances in your own kitchen. With dozens of models, seven color choices, Nickel or Antique Copper trims, and many options to choose from; there's an Antique appliance, or a full suite of appliances, that's just right for your taste... your cooking style... your kitchen.

**Elmira
Stove
Works**

And make your own personal statement! Each Elmira Stove Works appliance is custom crafted to your request. Our ranges offer thousands of combinations of styles, colors and features. Add our selection of spectacular refrigerators, microwaves, wall ovens and dishwasher panels, and the possibilities are endless!



1865-ST DUAL FUEL (with electric oven)

Six burner range shown in Black with 4 gas and 2 smoothtop electric elements, and electric oven.

- Options shown include:
- Antiquing
 - Nickel door frames
 - Nickel front legs
 - Nickel Victorian trivet



1855-STE-C ALL ELECTRIC

Six burner range shown in White with STE smoothtop and convection oven. Range top controls are hidden in the upper cabinet.

- Options shown include:
- Nickel door frames
 - Nickel front legs



**1860 ALL GAS
1870 DUAL FUEL (with electric oven)**

Four burner range shown in Black with gas cooktop.

- Options shown include:
- Antiquing
 - Nickel door frames
 - Nickel front legs
 - Nickel Victorian trivet



**1867-0 ALL GAS
1865-0 DUAL FUEL (with electric oven)**

Four burner range shown in Cayenne Pepper Red with gas cooktop and work surface on right side.

- Options shown include:
- Antiquing
 - Nickel front legs
 - Nickel Victorian trivet



1850-5 ALL ELECTRIC

Four burner range shown in Cayenne Pepper Red with cast element top.

- Options shown include:
- Nickel door frames
 - Nickel front legs
 - Nickel front skirt
 - Nickel warming shelf

Choose from seven colors - Black, White, Bisque, Cayenne Pepper Red, Liberty Blue, and our Black / Bisque and Black / White combinations. Pick one of our two trims – Nickel or Antique Copper. Choose the standard trim provided for a more subdued look... or dress up your appliances with more trim and accents for a bolder statement.

It's easy to choose! This catalog and our website will help you create your own range and your complete Elmirastove kitchen. Use the "Create Your Dream Kitchen" tools on our website to build your models, colors and trim choices; then view them installed in a virtual kitchen.



1855-STE-C ALL ELECTRIC

Six burner range shown in Black/White with STE smoothtop and convection oven. Range top controls are hidden in the upper cabinet.

- Options shown include:
- Nickel door frames
 - Nickel front legs
 - Nickel front skirt
 - Nickel Victorian trivet



1865-ST DUAL FUEL (with electric oven)

Six burner range shown in Black with 4 gas and 2 smoothtop electric elements, and electric oven.

- Options shown include:
- Antique Copper trim
 - Antique Copper door frames
 - Antique Copper front legs
 - Antique Copper Victorian trivet



**1867 ALL GAS
1875 DUAL FUEL (with electric oven)**

Six burner range shown in Liberty Blue with gas cooktop.

- Options shown include:
- Nickel door frames
 - Nickel front legs
 - Nickel front skirt
 - Nickel Victorian trivet



1850-STE-C ALL ELECTRIC

Four burner range shown in Black with smoothtop and convection oven. Range top controls are hidden in the upper cabinet.

Options shown include:

- Antique Copper trim
- Antique Copper door frames
- Antique Copper front legs
- Antique Copper front skirt
- Antique Copper Victorian trivet

1850-STE-C ALL ELECTRIC

Four burner range shown in Black/White with smoothtop and convection oven. Range top controls are hidden in the upper cabinet.

Options shown include:

- Nickel door frames
- Nickel front legs

**1867-0 ALL GAS
1875-0 DUAL FUEL (with electric oven)**

Four burner range shown in Bisque with gas cooktop and work surface on right side.

Options shown include:

- Nickel warming shelf

Elmira offers eight range tops to suit your cooking needs and style. Choose from traditional cast electric elements, high-speed radiant elements under ceramic smoothtops, high-efficiency, high-output sealed gas burners – or combinations of the three. Prefer a gas top and electric oven? You’ll love our “dual fuel” options. Convection? True convection models are available on all of our electric or dual fuel platforms.



GAS BURNERS – 1867 & 1875

- three 8,000 BTU gas burners
- two 12,000 BTU gas burners
- one 15,000 BTU “Superburner”
- available on 45” ranges



GAS BURNERS – 1860 & 1870

- two 8,000 BTU gas burners
- one 12,000 BTU gas burner
- one 15,000 BTU “Superburner”
- available on 30” ranges



GAS BURNERS – 1865-0 & 1867-0

- two 8,000 BTU gas burners
- one 12,000 BTU gas burner
- one 15,000 BTU “Superburner”
- work surface on right
- available on 45” ranges



COMBINATION – 1865-ST

- two 8,000 BTU gas burners
- one 12,000 BTU gas burner
- one 15,000 BTU “Superburner”
- one 6” 1,500 Watt radiant element
- one 8” 2,000 Watt radiant element
- available on 45” ranges



SMOOTHTOPS – 1855-STE-C

- three 6” 1,500 Watt radiant elements
- two 8” 2,000 Watt radiant elements
- one 9” 2,500 Watt “Superburner”
- controls hidden in upper cabinet
- 20% more cooking / work surface
- available on 45” ranges



SMOOTHTOPS – 1850-STE-C

- two 6” 1,500 Watt radiant elements
- one 8” 2,000 Watt radiant element
- one 9” 2,500 Watt “Superburner”
- controls hidden in upper cabinet
- 20% more cooking / work surface
- available on 30” ranges



“FEATHER TOUCH” ELECTRONIC CONTROL PANEL

The tempered glass control panel is conveniently located at eye level in the upper cabinet. Touch the screen lightly to select oven mode, then touch “Start”. Oven temperatures are easily controlled from 100 to 500 degrees F. (Control always indicates temperature selected.) Indicator lights on the control panel and cooking surface tell you which function is being used. The cooktop light and exhaust fan are also controlled from this panel.



CAST ELEMENTS – 1855-5

- three 6” 1,500 Watt “Ultra Temp” elements
- three 8” 2,000 Watt “Ultra Temp” elements
- available on 45” ranges



CAST ELEMENTS – 1850-5

- two 6” 1,500 Watt “Ultra Temp” elements
- two 8” 2,000 Watt “Ultra Temp” elements
- available on 30” ranges



“ULTRA TEMP” CAST ELEMENTS

Cast elements adjust temperature slightly more slowly than smoothtops, but cooking is very uniform. These elements resemble traditional cookstove firebox “lids”. Temperature limiters reduce power to the burner in the event of a pot boiling dry.



SMOOTHTOP ELECTRIC BURNERS

High-speed radiant elements under a ceramic cooktop provide virtually instant heat, uniform cooking and easy clean up. Heat is directed vertically so only the cooking zone gets hot. Infinite controls allow you to “fine tune” burners for precision cooking. Temperature limiters reduce heat in the event of a boil-dry.



SEALED GAS BURNERS

Pilotless sealed gas burners are rated at 8,000, 12,000 and 15,000 (“Superburner”) BTU’s*. Adjust simmer settings as low as 450 BTU’s. Safety feature: automatic spark ensures constant heat – re-ignites, even at the lowest setting. Burners will light at any knob position.

*BTU ratings based on natural gas.



GRIDDLES

Black Diamond non-stick griddles are great for frying eggs, pancakes, bacon, etc.; and especially for thawing frozen foods. (The aluminum composition draws the cold out of frozen foods very quickly.) These 11” x 19” griddles are available to fit any Elmira range.

COLORS

Standard Colors: Black, White, Bisque, Cayenne Pepper Red, Liberty Blue

Premium Colors: Black / White combination, Black / Bisque combination

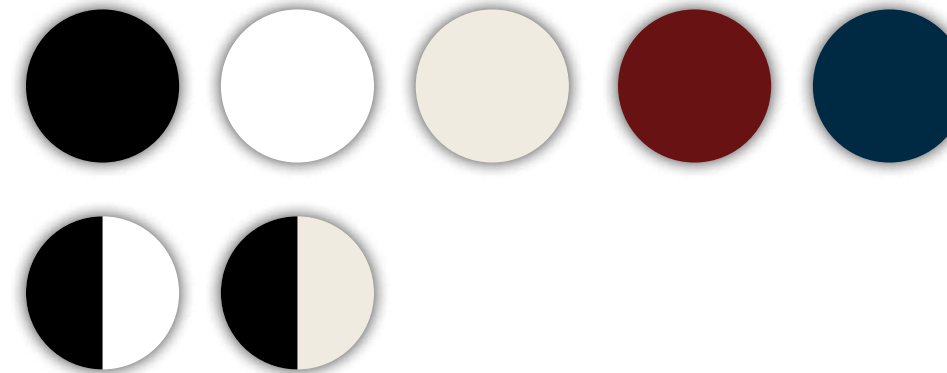

FULL-SIZE OVEN

Enjoy the advantages of a state-of-the-art full size self-cleaning oven without sacrificing the authentic look of an antique two-door range. The front panel displaying the “fire door”, “oven door” and “ash catch” cleverly conceals the spacious 4.3 cubic foot oven (4.0 cubic feet on gas or convection models) behind.



TRUE CONVECTION OVEN

“True convection” – at the push of a button, the standard oven converts to convection mode. A third heating element surrounding the convection fan circulates air evenly throughout the oven. Cooking times are reduced up to 25%, and you can bake five racks* of cookies / three racks of muffins perfectly at consistent temperatures. Procedures are fully explained in the owners’ manual.

*Three racks supplied – additional racks are available.



“STAY HOT” FOOD WARMER

Need to keep a few items warm while finishing off those last few dishes in the main oven? You’ll love our “Stay Hot” food warmer. Simply flip a switch and the two cubic foot warmer maintains a temperature of 200 degrees F. The warmer also doubles as a storage compartment when not in use. This is a standard feature on all 45” ranges.

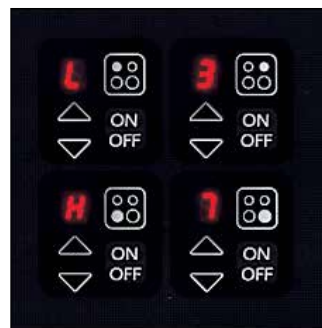

ELECTRONIC SMOOTHTOP CONTROLS ON STE MODELS

Electronic burner controls are hidden at eye level, maintaining the cooktop’s traditional appearance. Touch ON/OFF to turn a burner on or off. Then select the up or down arrow to adjust temperature to any of eleven settings. This feature increases your usable cooking surface by almost 20%!



VICTORIAN TRIVET

Cast from an authentic circa 1880 pattern, then plated and polished in Nickel or Antique Copper. The trivet looks spectacular when combined with matching legs, frames or skirt and antiquing. (Antiquing is not recommended with copper trims.)



WARMING SHELF

Decorative 3” by 28” shelf sits between the cabinet brackets to handily store spices, timers, etc. Available in Nickel and Antique Copper.



SHORT LEGS

Anyone shorter than 5’2” will appreciate the convenience of legs 2” shorter than standard. Available in any finish - color or metallic. Minimum base cabinet opening required with short legs is 30 3/4”; ideal opening is 33”.



LEGS & SKIRT

Nickel legs and skirts nicely accent any of our ranges. Also available in Antique Copper.



ANTIQUING

Decorative scroll work around door castings is manually buffed to expose the silver metal beneath, giving ranges and wall ovens an even more antique appearance. Antiquing is not recommended with Copper accents, or on White or Bisque appliances.



DOOR FRAMES

Add a touch of elegance to your range with polished Nickel or Antique Copper door frames.



DECORATIVE METAL TRIMS

Elmira offers two decorative metal trims for your appliances. Choose from our traditional Nickel finish, or upgrade to our deep, rich Antique Copper finishes.

Standard metal trim: Nickel door handles, cabinet frame & brackets, cook top trim rail, “ash catch” and thermometer.

Antique Copper trim package includes Copper door handles, cabinet frame and brackets, cook top trim rail, “ash catch” and thermometer. Also available: Antique Copper door frames, legs, skirts, Victorian trivet and decorative shelf.

With three models, seven colors and two metal trims, there's an Elmira Antique refrigerator to suit your kitchen!

Our French door models offer the convenience of double door access to fresh foods, along with a choice of 25 cubic feet of capacity (Model 1898) or the built-in look of our 20 cubic foot Model 1899. If you need to fit your fridge into a 30" cabinet opening, our Model 1896 30" fridge provides 18.5 cubic feet of capacity, with a bottom mount freezer.



Above: Model 1898 36" Full-Depth French Door in Black, Model 1899 36" Cabinet-Depth French Door in White and Model 1896 30" Bottom Mount in Cayenne Pepper Red.

1898 / 1899 FRENCH DOOR

Full-depth Model 1898 or cabinet-depth Model 1899 refrigerators offer state-of-the-art features with the convenience of the French Door design. Refrigerated foods and water dispenser are in the upper compartment for handy access. Oversized door bins, factory-installed standard ice maker, and slide-out shelves, drawers & baskets make this a very "smart" fridge.

Shown with optional Nickel door frames.



1896 BOTTOM MOUNT

1896 BOTTOM MOUNT Model 1896 offers 18.5 cubic feet of capacity, yet fits into a 30" cabinet opening. The bottom-mount (fridge-over-freezer) design keeps fresh food, the things you use most, at eye level for easy access. The roll-out freezer drawer puts frozen foods at your finger-tips.

Available with optional ice maker and / or left hand hinge.

Shown with optional Nickel door frames.



ANTIQUE CHARM WITH TODAY'S FEATURES.



WATER DISPENSER

(1898 and 1899)

Internal filtered water dispenser – fresh cold water "on demand".



ELECTRONIC CONTROL & WATER FILTER

(1898 and 1899)

Filter provides crystal clear drinking water. Separate fridge & freezer controls.



GLIDE-OUT FREEZER BASKETS

(All Models)

Double-basket design optimizes storage in freezer.



GLIDE-OUT FREEZER DRAWER

(All Models)

Bottom bins slide out to bring frozen foods within easy reach.



TEMPERATURE-CONTROLLED PANTRY DRAWER

(1898 and 1899)

Helps keep meats, cheeses, deli / party trays, etc. fresh & tasty.



DURABLE LEXAN BINS

(All Models)

Including crisper and deli bin.



HIGH VISIBILITY DESIGN

(All Models)

Transparent bins and shelves, fully adjustable slide-out shelving and drawers.



OVERSIZED DOOR BINS

(All Models)

Deep wide bins store large containers, maximize space utilization.



ENERGY STAR EFFICIENCY

All refrigerators are Energy Star compliant for energy efficiency.



Elmira ranges are spectacular... a full Elmira kitchen is absolutely stunning!

Create a focal point and warm gathering place in your home - complete your kitchen style statement with a matching microwave, wall oven and dishwasher. The results will amaze you!

1880 WALL OVEN (5.0 cu. ft.)

The 1880 wall oven is a must for people who require extra capacity. This 5.0 cubic foot self-cleaning convection oven can be installed in a wall or island. Wall ovens can be installed two-high.

Available in Black, White, Bisque, Cayenne Pepper Red, Liberty Blue, Black / White combination and Black / Bisque combination. Optional trim in Antique Copper, and optional door frames in Nickel or Antique Copper.



1895 MICROWAVE OVEN (2.2 cu. ft.)

Model 1895 is a deluxe 1,200 Watt microwave oven, featuring 10 power levels, auto-defrost and four-stage programmable sensor cooking.

Available in Black, White, Bisque, Cayenne Pepper Red, Liberty Blue, Black / White combination and Black / Bisque combination. Optional door frame in Nickel or Antique Copper.



1893 DISHWASHER PANEL

Model 1893 fits most 24" wide fully integrated dishwashers that accept 3/4" panels up to 17.5 lbs. Contact your dishwasher retailer to determine which current models are compatible. Panel dimensions are 30-5/16" high by 23-1/2" wide – the panel will also fit dishwashers with slightly smaller doors.

Available in Black, White, Bisque, Cayenne Pepper Red, Liberty Blue, Black / White combination and Black / Bisque combination. Optional door frame in Nickel or Antique Copper.

Note: Antiquing is not available on microwaves, dishwasher panels and wall oven control panels.

RANGES – FEATURES & SPECIFICATIONS

	ELECTRIC RANGES		COMBINATION RANGES			ALL GAS RANGES		ELECTRIC WALL OVENS
Range Widths	1850	1855	1865	1870	1875	1860	1867	1880
OVENS								
Self-Cleaning Electric Oven (4.3 cu. ft.) Oven Size: 25" W x 16" H x 18 3/4" D	●	●	●	●	●			
Electric Self-Cleaning Convection Oven (4.0 cu. ft.) Oven Size: 25" W x 16" H x 16 5/8" D	optional standard on STE Models	optional	optional	optional	optional			5.0 cu. ft.
Gas Self-Cleaning Oven with waist high Broiler (4.0 cu. ft.) Oven Size: 25" W x 16" H x 18" D						●	●	
"Stay Hot" Food Warmer		●	●		●		●	
Electronic Oven Control	●	●	●	●	●	●	●	●
Delayed Start Baking	●	●	●	●	●	●	●	●
Dual Element Baking	●	●	●	●	●			●
Vari. Temp. Broil	●	●	●	●	●	●	●	●
Door Activated Oven Light	●	●	●	●	●	●	●	●
Heavy Duty, Plated Oven Racks	●	●	●	●	●	●	●	●
Porcelain Enamel Broiler Pan	●	●	●	●	●	●	●	
Sabbath Mode								●
RANGETOPS								
Electric High-speed Radiant Elements under glass (ST)	optional	optional						
High-Speed Radiant Elements under glass with Electronic Control (STE)	optional	optional						
Gas: Sealed Surface Burners with cast grates			4	●	●	●	●	
Converts to L.P. (Propane)			●	●	●	●	●	
Gas Top Burners, 8,000* BTU			2	2	3	2	3	
Gas Top Burners, 12,000* BTU			1	1	2	1	2	
Superburner, 15,000* BTU			1	1	1	1	1	
*Ratings for liquid propane are approximately 10% lower								
Ultra Temp™ Electric Cast Elements	optional	optional						
Electric High Speed Radiant Elements under glass			optional					
Porcelain Enamel Work Surface (replaces two burners/elements)			optional				optional	
Electronic Spark with Re-ignition			●	●	●	●	●	
Easy Clean Porcelain Top or Top Frame	●	●	●	●	●	●	●	
Nickel Trimmed Range Top	●	●	●	●	●	●	●	
UPPER CABINET								
350 CFM Exhaust Fan standard (recirculating and outside vent)	●	●	●	●	●	●	●	
485 CFM Wall Mounted Exhaust Fan (outside mount, outside vent)	optional	optional	optional	optional	optional	optional	optional	
636 CFM In-line Exhaust blower (outside vent only)	optional	optional	optional	optional	optional	optional	optional	
Cooking Surface Light, Night Light	●	●	●	●	●	●	●	
"Feather Touch" Tempered Glass Oven Control Panel	●	●	●	●	●	●	●	
POWER RATING								
Power Source (208 to 250V) appliance rating	240V-35A	240V-50A	240V-30A	240V-30A	240V-30A	120V-5A	120V-6A	240V-30A
Power Ratings NG (BTU's)			43,000	43,000	63,000	59,000	79,000	
Power Ratings LP (BTU's)			38,700	38,700	56,700	53,100	71,100	
Power ratings/oven burner NG (BTU's)						16,000	16,000	
Shipping Weight	390 lbs.	425 lbs.	435 lbs.	400 lbs.	440 lbs.	410 lbs.	450 lbs.	200 lbs.

Natural gas or propane?
Ranges are built to accommodate natural gas unless propane (LP) has been specified on your order. Conversion parts are available and are easy to install. (See product manual for instructions.)

RANGE DIMENSIONS

(Subject to change. Consult the product manual or contact Elmira Stove Works for complete and current dimensions.)

Four-Burner Models: Our standard leg four-burner models will fit into a 30-1/4" countertop opening* and 30-3/4" lower cabinet opening**. Short leg models, or countertops higher than 36", require a minimum 31" countertop opening and 30-3/4" lower cabinet opening.

Six-Burner Models: Our standard leg six-burner models require a minimum 44-1/2" countertop opening*. Short leg models, or countertops higher than 36", require a minimum 45-1/2" countertop opening.

* Recommended countertop overhang is 1".

** Required lower cabinet opening on 4-burner standard leg models can be reduced to 30-1/4" by removing side skirts.

Vertical dimensions 2" less on short leg models.

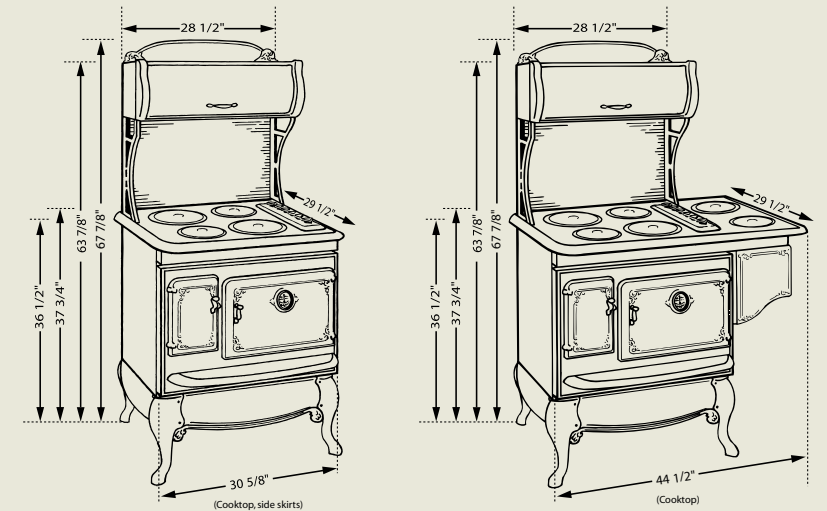

STANDARD EXHAUST FAN

The standard 350 c.f.m. exhaust fan, included in the upper cabinet of your range, is factory-set to recirculate air through a charcoal filter. It can also be used to outside-vent exhaust if there is not more than one 90 degree elbow or more than ten feet between the range and the outside wall. This fan exhausts air only from the back of the range cabinet – it cannot be adapted for top-venting.

EXHAUST OUTLET LOCATION

Height from floor to center of duct opening is 62 5/8" (60 5/8" for short leg models). From left base cabinet countertop overhang to center of duct opening is 15 3/8".

#1518 OPTIONAL IN-LINE EXHAUST BLOWER

The optional in-line exhaust blower replaces the standard 350 c.f.m. exhaust fan provided in your range cabinet, and is to be installed by your contractor where your exhaust ducting exits the house. The inline blower should be ordered when you purchase your range - the range and wiring must be modified to accommodate the blower. (The blower can be shipped in advance of the range for installation – additional shipping charges will apply.)

If you are outside-venting your range with more than 10 feet of ducting, or more than one elbow... or if you simply prefer a more powerful exhaust system ... you should include the optional 636 c.f.m. in-line exhaust blower. The #1518 In-Line Blower exhausts smoke and cooking odors quickly and quietly, exiting the house up to 35 feet from the range. If desired, the blower can be mounted in the basement or attic for powerful, whisper-quiet operation.

- The blower can be mounted vertically, horizontally or at any angle.
- Backward-curved airfoil blades move maximum air with minimal sound.
- Fan and motor are precision balanced for quiet vibration-free operation.
- Blower wiring attaches to the junction box on the back of your range.

SPECIFICATIONS:

- 636 cu. ft. / minute, 210 Watts, 115 Volts, 1.85 Amps, 60 Hz • Blower length: 9-1/8"
- Blower diameter: 13-1/2" (electrical box protrudes 1-3/4"D X 4-1/2"W from side of blower Inlet / outlet: 8"
- Warranty: One year

IN-LINE EXHAUST BLOWER KIT CONTAINS:

- Exhaust blower with 8" inlet and outlet
- Adapter elbow – attaches to back of range, converts range outlet to 3-1/4" X 10" standard duct size.
- Duct adaptor – converts 3-1/4" X 10" duct to 8" round duct
- Back draft damper with spring return – prevents cold air from entering house when blower is not in use.
- Outside louver grill – covers the exhaust outlet at soffit or foundation wall.
- Louvers automatically close when the blower is not in use.
- Duct extender – mounts to back of range cabinet, replacing deflector plate.
- Duct pipe, roof flashing and roof cap (if required) are not included.

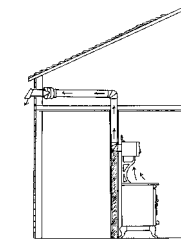

ATTIC IN-LINE EXHAUST BLOWER

The in-line blower and ducting can be mounted to or between (allowing for 14" blower diameter) structural joists. Alternate installation: The exhaust duct can extend straight up through the roof (similar to Installation #3). This method will require a roof flashing and cap, not included.

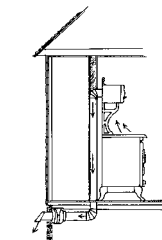

BASEMENT IN-LINE EXHAUST BLOWER

The exhaust duct runs down the wall behind the range into the basement, where it exits through the foundation wall. The in-line blower and ducting can be mounted to or between (allowing for 14" blower diameter) structural joists.

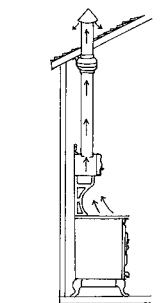

ROOF IN-LINE EXHAUST BLOWER

(straight up from cabinet)

Log homes and homes with a cathedral ceiling often require a top-ducted exhaust. Advise your dealer if you are using this application – a 7" round hole must be made in the top center of your range cabinet. We highly recommend locating your range in the kitchen prior to cutting the hole in the roof. (Ducting can also be routed through kitchen cabinets above range, if desired.) 7" duct pipe, 7" to 8" increaser, roof cap and roof flashing not included.

OUTSIDE WALL EXHAUST

There are two options for venting an Antique range directly through an outside wall behind the range:

1. **Using the standard 350 CFM fan** (noted above left), the exhaust outlet on the back of the range cabinet can be connected to standard 3-1/4" X 10" ducting and vented through the wall behind the range.
2. **For extra power, a 485 CFM Model 1519 wall-mounted exhaust fan** can be installed on the outdoors side of the wall, exhausting through the wall directly behind the range. The 3-1/4" x 10" duct from the back of the range must transition to 6" round to connect to the external blower. The Model 1519 blower replaces the standard exhaust fan provided in your range cabinet, and must be ordered when you order your range.

REFRIGERATORS – FEATURES & SPECIFICATIONS

	1896 Bottom Mount	1898 French Door Full Depth	1899 French Door Counter Depth
CAPACITY			
Total Fridge & Freezer (cu. ft.)	18.5	25.0	20.0
Total Freezer (cu. ft.)	5.73	7.44	5.62
Total Fridge (cu. ft.)	12.94	17.75	14.38
REFRIGERATORS / FREEZER FEATURES			
Fully adjustable shelving	●	●	●
Gallon size adjustable door storage	●	●	●
Sealed vegetable crisper with adjustable humidity control	●	●	●
Deli bin	●	●	●
Crispers and bins made of clear durable Lexan™	●	●	●
Beverage rack	●	●	●
Slide out upper freezer basket	●	●	●
Separate fridge / freezer controls	●	●	●
Internal filtered water dispenser	N/A	●	●
Factory installed ice maker	Optional	Standard	Standard
EnergyStar	●	●	●
Energy Guide (US) / EnerGuide (CDN) Rating (KwH/yr.)	521 / 441	615 / 449	563 / 405
Shipping weight (lb.)	370	460	400
CABINET FEATURES			
Injection molded fiberglass doors with enamel coating	●	●	●
Adjustable rollers provide easy movement for cleaning	●	●	●
Sculptured door handles	●	●	●
Coil free back, clean-free condenser	●	●	●
Left hand hinge	Optional	N/A	N/A
COLORS			
Standard - Black, White, Bisque, Cayenne Pepper Red, Liberty Blue	●	●	●
Premium - Black/White combination, Black/Bisque combination	●	●	●
Standard Door Handles	Nickel	Nickel	Nickel
Antique Copper door handles	Optional	Optional	Optional
Nickel or Antique Copper door frames	Optional	Optional	Optional
DIMENSIONS - See diagram on facing page			
A Height to top of door	67 ¼"	69 ⅞"	69 ⅞"
Height to top of hinge	66 ½"	69 ⅞"	69 ⅞"
B Height to top of case	65 ¾"	68 ⅝"	68 ⅝"
C Depth not including door	28 ¼"	29"	24"
D Depth including door	33 ¾"	34"	29"
E Depth including door and handles	33 ¾"	35 ⅜"	30 ⅜"
F Depth with door(s) open 90 degrees	59 ½"	48 ¼"	43 ¼"
G Depth with freezer drawer open	52 ½"	54 ¾"	46"
H Width of case	29 ¼"	35 ⅝"	35 ⅝"
I Width with door(s)	30"	36"	36"
Width with door(s) open 90 degrees (not incl. handle)	32 ¼"	42 ⅞"	42 ⅞"
Side clearance from wall for doors to open 90 degrees	2 ½"	4"	4"
Cutout dimensions:			
Width	30"	36"	36"
Height	67"	70"	70"
Minimum depth	24"	24"	24"
Ideal depth	28"	28"	24"

REFRIGERATOR DIMENSIONS

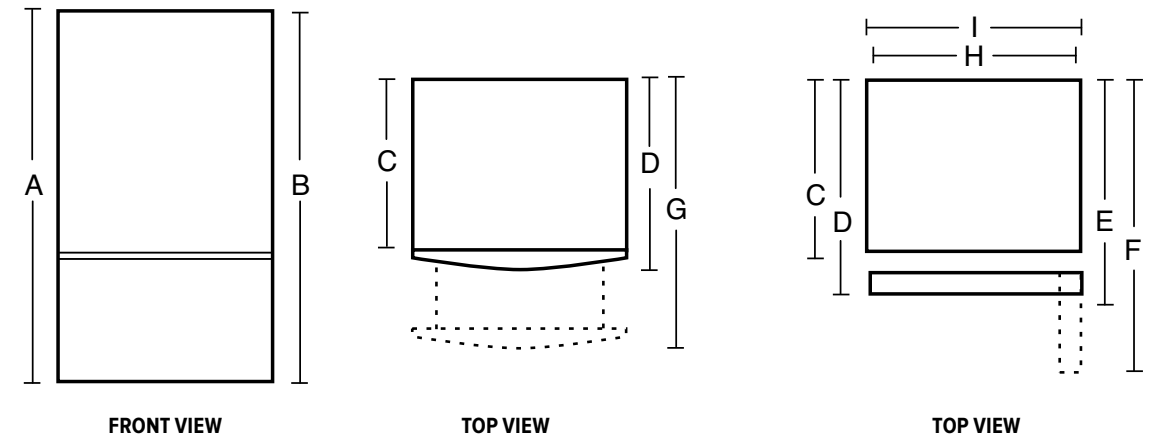

MICROWAVES & WALL OVENS – FEATURES & SPECIFICATIONS

	1895 Microwave	1880 Wall Oven
CAPACITY		
	2.2 cu. ft.	5.0 cu. ft.
OVERALL DIMENSIONS:		
Height	14"	30 ¼"
Width	24"	30"
Depth	20"	28"
Depth with Doors, Ash Catch		33-½"
CABINET CUT-OUT DIMENSIONS (Minimum)*		
Height	14-¼"	28"
Width	24-¼"	28-½"
Cabinet Width		30"
Depth	24"	24"
Rear Stop Depth	15-½"	N/A
POWER SOURCE		
	120V, 15A	220V, 30A
SHIPPING WEIGHT		
	65 lb.	200 lb.

*MICROWAVE OVEN NOTES:

Model 1895 is designed as a countertop unit. If built into cabinets, allow a minimum total of 30 square inches of ventilation space around the face of the unit – top, sides and bottom. This can be accomplished with open space, louvers, slots, etc.

*WALL OVEN NOTES:

Allow 5 ¼" minimum from bottom of cutout to floor. Allow 1 ½" minimum from top of cutout to underside of counter-top. Wall ovens can be installed two high.

WARRANTY

One-year warranty, covering parts and labor. Additional four-year warranty (five years total) parts only on range / wall oven burners and elements, fridge sealed refrigeration unit and compressor, and microwave inverter.

NOTE RE ELECTRICAL & GAS SUPPLY

All 240 Volt ranges – standard cord is four prong 50 amp plug. Please specify if a three-prong cord is required (home construction / wiring 1998 or prior).

All ranges - the electrical receptacle and gas piping should be installed approximately 4" above the floor and 15" from the left edge of the cabinet opening.

ALL DIMENSIONS ARE FOR PLANNING PURPOSES ONLY

Specifications are subject to change without notice. We reserve the right to make product changes as required, without notice. Consult installation instructions before cutting cabinets, counter tops or exhaust outlet.

SAFETY & EFFICIENCY

Elmira Stove Works appliances meet or exceed the most stringent U.S. and Canadian safety and efficiency standards.

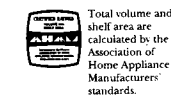

“Let’s Create Your Dream Kitchen”

Visit www.ElmiraStoveWorks.com to build your own dream kitchen. Select your cabinet color, and then choose your appliances (models, colors, trims and options). The “visualizer” displays your appliances in the kitchen and prices them for you!



Elmira
Stove For true originals
Works

Elmira Stove Works

285 Union Street,
Elmira, Ontario N3B 3P1

Phone: (519) 669-1281 | Fax: (519) 669-1774 | Toll-Free: 1-800-295-8498

ElmiraStoveWorks.com