

INFRARED™ X4 GAS INSERT

Specifications

Model	BTU	Width		Height		Depth		Glass
		Minimum	Actual	Minimum	Actual	Minimum	Actual	
XIR4	40,000	34 1/4	34 3/4	25	24 1/2	17	16 5/8	120 5/8 X 31

Overview

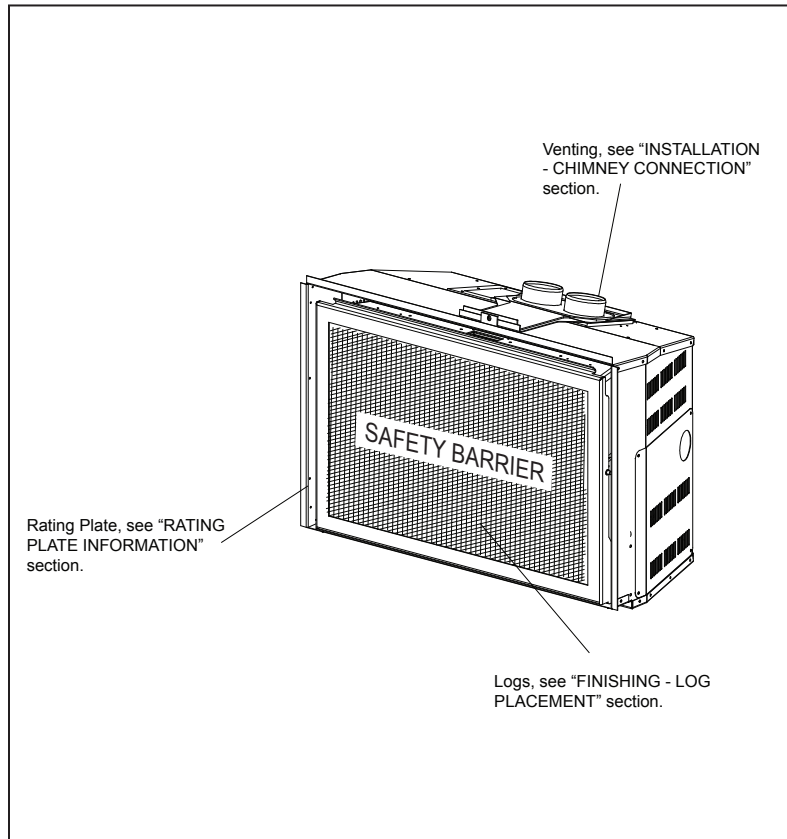

Dimensions

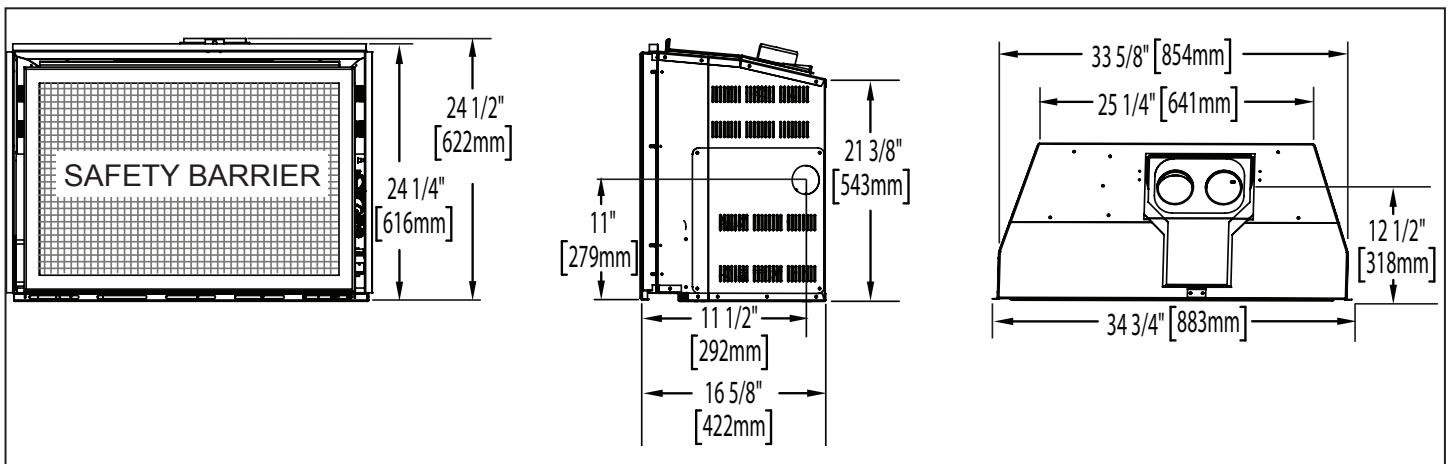

INFRARED™ X4 GAS INSERT

Framing & Clearances

Minimum Fireplace Clearances

This appliance must be recessed into a vented noncombustible wood-burning appliance (prefabricated or masonry) only. The minimum appliance opening size in which the appliance is to be installed is:

HEIGHT 25" (635mm) WIDTH 34.25" (870mm) DEPTH 17" (432mm)
The minimum allowable chimney flue size is 7" (178mm) round.

The minimum distance, from the bottom of a combustible mantel projecting 3" (76mm) maximum from the wall to the top of the appliance, is 14" (356mm) (see "MINIMUM MANTEL CLEARANCES" section).

General Information

	XIR4-1	
	NG	LP
Altitude (FT)	0-4,500	0-4,500
Max. Input (BTU/HR)	40,000	40,000
Max. Output (BTU/HR)	33,200	33,200
Efficiency (w/the fan on)	83%	83%
A.F.U.E. (maximum value)	79%	79%
Min. Inlet Gas Supply Pressure	4.5" Water Column (11mb)	11" Water Column (27mb)
Max. Inlet Gas Supply Pressure	7" Water Column (17mb)	13" Water Column (32mb)
Manifold Pressure (Under Flow Conditions)	3.5" Water Column (9mb)	10" Water Column (25mb)

Log Placement

PHAZER™ logs and glowing embers exclusive to Napoleon, provide a unique and realistic glowing effect that is different in every installation. Take the time to carefully position the glowing embers for a maximum glowing effect. Log colours may vary. During the initial use of the appliance, the colours will become more uniform as colour pigments burn in during the heat activated curing process.

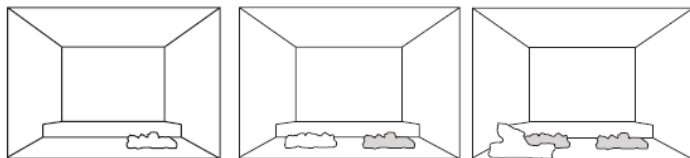

- Place the right charcoal piece into position, lining up the holes in the bottom with the studs in the right side of the burner.
- Place the left charcoal piece into position, lining up the bottom holes with the studs to the left side of the burner.
- Place the left front charcoal piece* into position, lining up the holes in the bottom with the studs in the left front corner.

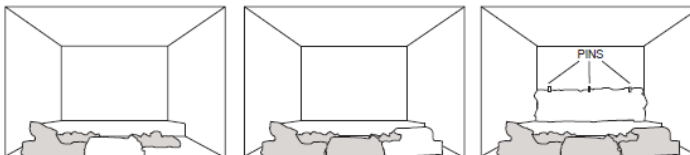

- Place the centre charcoal piece* into position, lining up the hole in the bottom with the stud in the front centre of the log support.
- Place the right front charcoal piece* into position, lining up the holes in the bottom with the studs in the front right corner.
- Place the rear log against the back panel, lining up the holes with the studs at the back of the firebox. Locate 3 pins (supplied) into the top of the log.

Product information provided is not complete and is subject to change without notice. Please consult the installation manual for the most up to date installation information.

Chimney Connection

2-3" DOUBLE PLY ALUMINUM LINER-INLET AND EXHAUST:

GDI-320KT	VENT KIT 20FT (6m)
GDI-325KT	VENT KIT 25 FT (7m)
GDI-335KT	VENT KIT 35 FT (11m)

While the liners must be continuous from the appliance to the chimney cap, to achieve the needed length, they may be coupled, using an approved coupler and sealant.

We recommend that exhaust vents that pass through unheated spaces, such as tall exterior chimneys, be wrapped in a protective sleeve to minimize condensation and reverse flow symptoms. See Trouble Shooting for details. This appliance is approved for use with a 3" (76mm) exhaust and air intake.

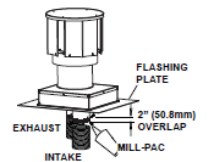

- A. **OUTSIDE:** Slip the one end of a liner a minimum of 2" (51mm) over the sleeve of the air terminal. Secure using 3 screws. Then seal the joint and screw heads with high temperature sealant. Repeat with the other liner.

NOTE: We recommend that the other end of the exhaust liner be marked to eliminate the exhaust liner being connected to the intake collar at the appliance.

- B. Gently stretch the liners to the required lengths and insert into the chimney. Trim and fit the flashing plate to suit the chimney termination. Place the air terminal onto the top of the chimney. Make weather tight by sealing with caulking (not supplied). Fasten to the chimney with screws and plugs (not supplied).

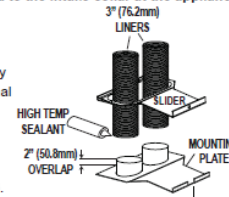

- C. **INSIDE:** Remove the securing screw from the front of the vent mounting plate. Pull the vent mounting plate only, back into the track, to the front stop. Start the slider back into position. Re-secure the screw. The appliance may now be pushed into its final position inside the wood burning appliance, and the screw tightened until the slider has been pulled tight to the front stop.

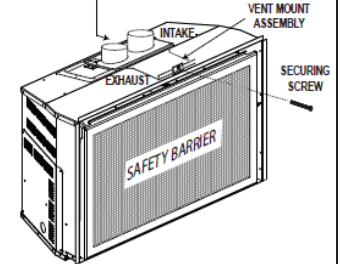

- D. Route the flex liners through the slider. Attach and secure the liners to the vent mounting plate using the same procedure as before, ensuring that the marked exhaust liner is attached to the exhaust collar.

Combustible Mantel Clearances

MANTEL DIMENSIONS

Ref	
A	17" (432mm)
B	16" (406mm)
C	15" (381mm)
D	14" (356mm)
E	6" (152mm)
F	5" (127mm)
G	4" (102mm)
H	3" (76mm)

