

ROXBURY™ 30 GAS INSERT

Specifications

Model	BTU	Width		Height		Depth		Glass
		Minimum	Actual	Minimum	Actual	Minimum	Actual	
GDI30	24,500	28	30 1/16	22	23 1/8	18	18 3/4	13 5/16 X 27 7/8

Overview

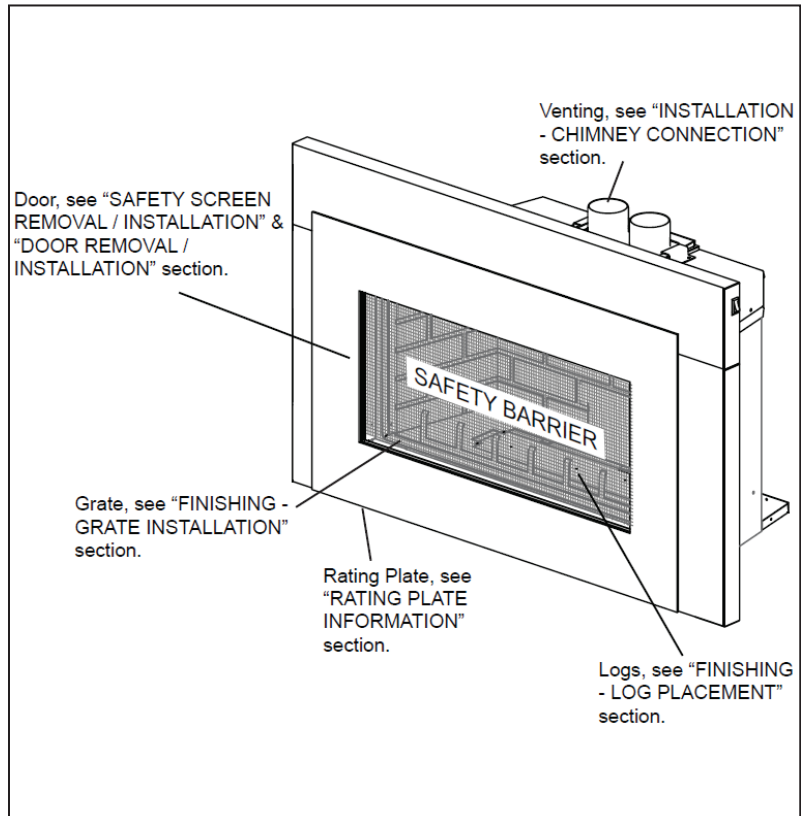

Dimensions

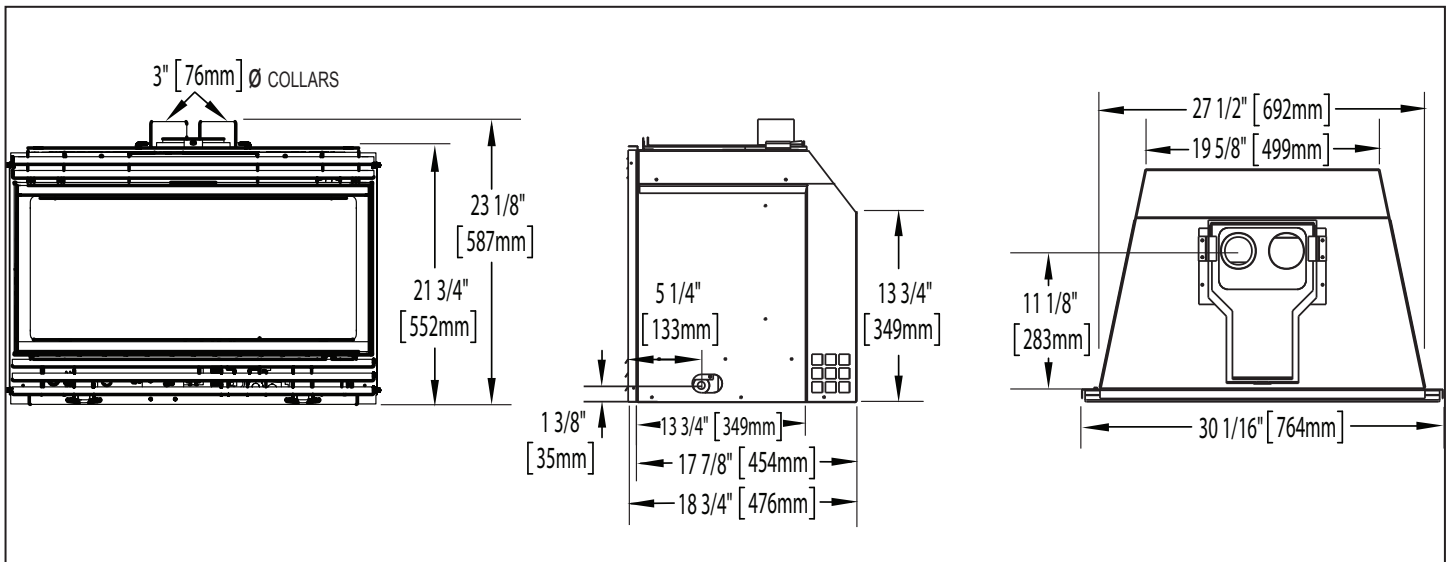

ROXBURY™ 30 GAS INSERT

Framing & Clearances

Minimum Fireplace Clearances

This appliance must be recessed into a vented noncombustible wood-burning appliance (prefabricated or masonry) only. The minimum appliance opening size in which the appliance is to be installed is:

HEIGHT 22" (559mm) WIDTH 28" (711mm) DEPTH 18" (457mm)
The minimum allowable chimney flue size is 6" (152mm) round.

The minimum distance, from the bottom of a combustible mantle projecting 3" (76mm) maximum from the wall to the top of the louvre opening, is 12" (305mm).

General Information

GDI-30		
	NG	LP
Altitude (FT)	0-4,500	0-4,500
Max. Input (BTU/HR)	24,500	24,500
Max. Output (BTU/HR)	20,825	20,825
Efficiency (w/the fan on)	85%	85%
A.F.U.E. (maximum value)	82%	82%
Min. Inlet Gas Supply Pressure	4.5" (11mb) Water Column	11" (27mb) Water Column
Max. Inlet Gas Supply Pressure	7" (17mb) Water Column	13" (32mb) Water Column
Manifold Pressure (Under Flow Conditions)	3.5" (9mb) Water Column	10" (25mb) Water Column

Log Set up

PHAZER™ logs and glowing embers exclusive to Napoleon, provide a unique and realistic glowing effect that is different in every installation. Take the time to carefully position the glowing embers for a maximum glowing effect. Log colours may vary. During the initial use of the appliance, the colours will become more uniform as colour pigments burn in during the heat activated curing process.

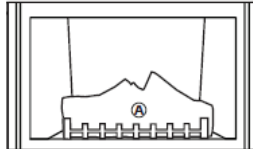

A. Place the rear log so that it rests against the two log brackets on the back wall of the firebox. The air space between the log and firebox back is used to facilitate combustion air flow.

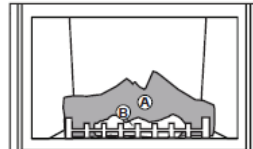

B. Move the charcoal strip into position lining up the holes in the bottom with the studs located on the burner on the burner. Ensure strip sits flat on the burner.

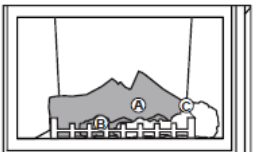

C. Position the front right log just behind the grate lining up the holes in the bottom with the studs located on the log support.

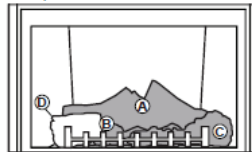

D. Move the left log into position lining up the hole in the bottom with the stud on the left side of the log support.

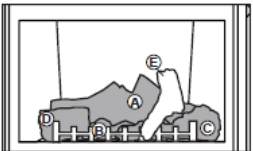

E. Line up the square hole in the right crossover with the square post located on the right side of log and install as shown.

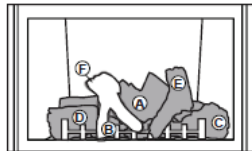

F. Line up the rectangular hole in the left crossover with the rectangular post located on the left side of log and install as shown.

Product information provided is not complete and is subject to change without notice. Please consult the installation manual for the most up to date installation information.

Chimney Connection

1-2"Ø (25.4mm-50.8mm) & 1-3"Ø (25.4mm-76.2mm) DOUBLE PLY ALUMINUM LINER-INLET AND EXHAUST & 2-3"Ø (50.8mm-76.2mm) TO 2"Ø (50.8mm) REDUCERS:

GDI-2320KT VENT KIT 20FT (6.1m)
GDI-2325KT VENT KIT 25FT (7.6m)
GDI-2335KT VENT KIT 35FT (10.7m)

2-3"Ø (50.8mm-76.2mm) DOUBLE PLY ALUMINUM LINER-INLET AND EXHAUST:

GDI-320KT VENT KIT 20FT (6.1m)
GDI-325KT VENT KIT 25 FT (7.6m)
GDI-335KT VENT KIT 35 FT (10.7m)

While the liners must be continuous from the appliance to the chimney cap, to achieve the needed length, they may be coupled, using an approved coupler. We recommend that exhaust vents that pass through unheated spaces, such as tall exterior chimneys, be wrapped in a protective sleeve to minimize condensation and reverse flow symptoms. See Trouble Shooting for details.

This appliance is approved for use with a 2" (51mm) liner for air intake and a 3" (76mm) liner for exhaust. For best performance, however, it is recommended to use two 3" (76mm) liners.

If a 2" (51mm) liner is used for the intake, it may be necessary to adjust the primary air shutter.

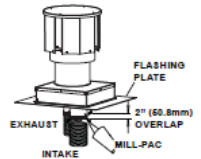

A. **OUTSIDE:** Slip the one end of a liner a minimum of 2" (51mm) over the sleeve of the air terminal. Secure using 3 screws. Then seal the joint and screw heads with W573-0007 Mill-Pac (not supplied). Repeat with the other liner.

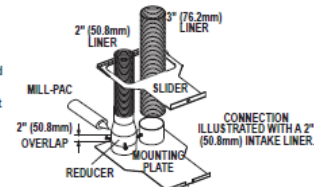

NOTE: We recommend that the other end of the exhaust liner be marked to eliminate the exhaust liner being connected to the intake collar at the appliance.

B. Gently stretch the liners to the required lengths and insert into the chimney. Trim and fit the flashing plate to suit the chimney termination. Place the air terminal onto the top of the chimney. Make weather tight by sealing with caulking (not supplied). Fasten to the chimney with screws and plugs (not supplied).

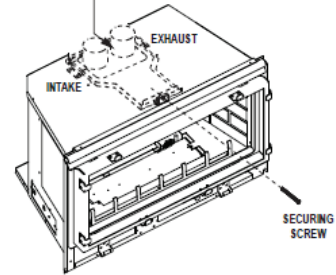

C. **INSIDE:** Remove the securing screw from the front of the vent mounting plate. Pull the vent mounting plate only, back into the track, to the front stop. Start the slider back into position. Re-secure the screw. The appliance may now be pushed into its final position inside the wood burning appliance, and the screw tightened until the slider has been pulled tight to the front stop.

D. Route the flex liners through the slider. Attach and secure the liners to the vent mounting plate using the same procedure as before, ensuring that the marked exhaust liner is attached to the exhaust collar.

Combustible Mantel Clearances

