

# Intrigue EZ



User manual for Intrigue EZ decorative gas appliance

## CAUTION



### DO NOT DISCARD THIS MANUAL

- Important operating and maintenance instructions included.
- Read, understand, and follow these instructions for safe installation and operation.



GAS-FIRED



## DANGER

If you smell gas:

- Shut off gas to the appliance
- Extinguish any open flame.
- If odor continues, keep away from the appliance and immediately call your gas supplier or fire department.



## WARNING

Do not store or use gasoline, or other flammable vapors and liquids, in the vicinity of this or any other appliance. An LP-cylinder not connected for use shall not be stored in the vicinity of this or any other appliance.



## WARNING



**HOT! DO NOT TOUCH.**

**SEVERE BURNS MAY RESULT.**

**CLOTHING IGNITION MAY RESULT.**

Glass and other surfaces are hot during operation and cool-down.

- Young children should be carefully supervised when they are in the area of the appliance
- Children and adults should be alerted to the hazards of high surface temperatures and should stay away to avoid burns or clothing ignition
- Clothing or other flammable materials should not be hung from the appliance or placed on or near the appliance.

Any guard or other protective device removed for servicing the appliance shall be replaced prior to operating the



**WARNING: For outdoor use only**



## WARNING



Improper installation, adjustment, alteration, service, or maintenance can cause injury or property damage. Read the installation and maintenance instructions thoroughly before installing or servicing this equipment.



## DANGER

### CARBON MONOXIDE HAZARD

This appliance can produce carbon monoxide which has no odor.

Using it in an enclosed space can kill you.

Never use this appliance in an enclosed space such as a camper, tent, car, or home.

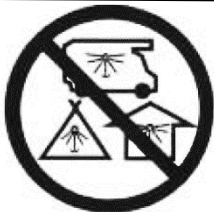

# Read this manual before installing or operating this appliance.

## Please retain this owner's manual for future reference.

Congratulations on selecting an Outdoor GreatRoom Company decorative gas appliance.

As a new owner of an Intrigue EZ, you'll want to read and carefully follow all of the instructions contained in this owner's manual. Pay special attention to all cautions and warnings.

This owner's manual should be retained for future reference. We suggest you keep it with other important documents and product manuals.

This information contained in this owner's manual, unless noted otherwise, applies to all models and gas control systems.

Your new Intrigue will give you years of durable use and trouble-free enjoyment.

<b>Homeowner Reference Information</b>	<i>We recommend that you record the following pertinent information about your appliance</i>
Model name: _____	Date of purchase/installation _____
Serial Number: _____	Location on appliance: _____
Dealer purchased from: _____	Dealer Phone: _____
Notes: _____	
_____	
_____	

### Listing Label Information/Location

The model information regarding your specific appliance can be found on the rating plate attached to your burner via a metal chain. See the sample rating plate at right for locations of specifications.

**GAS-FIRED**  
**C UL US LISTED 42W4**

**DECORATIVE OUTDOOR GAS-FIRED FIREPLACE**

**The Outdoor GreatRoom Company**  
14400 Southcross Dr. W , Suite 100  
Burnsville, MN 55306

Type of Gas: Propane Gas MFG. DATE/DATE DE FAB. XX/XX SERIAL # XXXX

Model: INTRIGUE EZ  
ANSI Z21.97-2014 and CSA 2.41-2014 for Canada. Installation must conform with local codes or in the absence of local codes, ANSI Z223.1 \* NFPA 54 National Fuel Gas Code – Natural gas and propane installation code, CSA B149.1 – or propane storage and handling code CSA B149.2

Model	Orifice Size	Max input BTU
INTRIGUE EZ	.49mm	3340

**WARNING:** Must Not Be Used For Cooking.  
**WARNING:** For Outdoor Use Only. If stored indoors, detach and leave cylinder outdoors.  
MINIMUM CLEARANCES: Top: 2 Ft. (24 in.) Sides: 0 in. Bottom: 0 in.  
Minimum clearance from sides and back of unit to adjacent combustible construction below top of unit is 0 inches from sides and 0 inches from back.  
Minimum horizontal clearance from sides and back of unit to adjacent vertical combustible construction extending above top of unit is 24 inches from sides and 24 inches from back.

**WARNING:** Improper installation, adjustment, alteration, service or maintenance can cause injury or property damage. Refer to the owner's information manual provided with this appliance. For assistance or additional information consult a qualified installer, service agency or the gas supplier.

INT-UL Rev A 6.30.16

# Table of Contents

<b>1. Listing and Code Approvals .....</b>	<b>4</b>
A. Appliance Certification .....	4
B. BTU Specifications .....	4
<b>2. Getting Started .....</b>	<b>5</b>
A. Design and Installation Considerations.....	6
B. Inspect the Appliance and Components.....	6
C. Framing enclosures for LP Supply Systems.....	7
<b>3. Fuel Information.....</b>	<b>7</b>
A. Fuel type.....	7
B. Gas connection.....	7
C. LP Gas supply .....	7
<b>4. Setting up the Intrigue.....</b>	<b>8</b>
A. Burner Assembly.....	8
B. Important Warnings and Safety Information.....	11
<b>5. Operating Your Intrigue.....</b>	<b>12</b>
<b>6. Troubleshooting.....</b>	<b>13</b>
<b>7. Service and Maintenance.....</b>	<b>14</b>
<b>8. Reference Materials.....</b>	<b>15</b>
<b>9. Limited 1-Year Warranty.....</b>	<b>16</b>

# 1 Listing and Code Approvals

## 1. Appliance Certification

**MODEL:** INTRIGUE EZ

**LABORATORY:** Underwriters Laboratories, Inc. (UL)

**TYPE:** Decorative Gas-Fired Outdoor Fireplace

**STANDARD:** IAS US requirements for Outdoor gas fireplaces, Draft 4-96 and CSA requirement for Outdoor Gas Fireplaces, CR-97-003

The Intrigue has been tested in accordance with IAS US requirements for Outdoor Gas Fireplaces, Draft 4-96 and CSA requirement for Outdoor Gas Fireplaces, CR-97-003 for Canada and has been listed by Underwriters Laboratory (UL) for installation and operation as described in these installation and operating instructions.

The installation must conform with local codes or, in the absence of local codes, with the National Fuel Gas Code ANSI Z223.1 or CAN/CGA-B149.1, National Gas Installation Code or CAN/CGA-B149.2, Propane Installation Code.

## B. BTU Specifications

Model	Max Input BTUH	Orifice Size
INTRIGUE EZ	3340 BTU/hr	.49mm

# 2 Getting Started

## Required Supplies



- **Leather Gloves**

To protect hands while installing glass cylinder



- **Two (2) D Batteries**

Required for powering valve and ignition system.

## What's Included:



**10"  
Glass  
Cylinder**

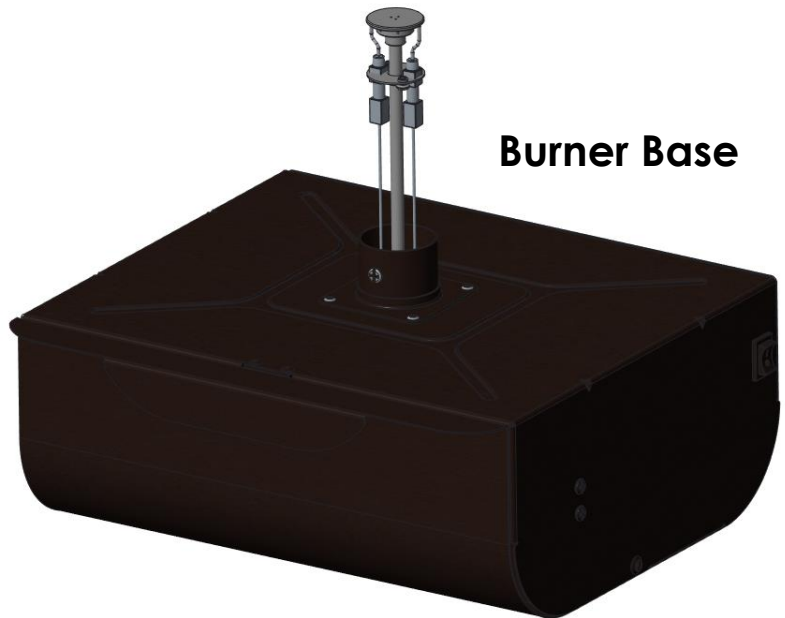

**Burner Base**



**Top  
Assembly**



**Silicon  
Glass Cover**



**Instruction  
Booklet**

This appliance is a Decorative Gas Appliance for **OUTDOOR USE ONLY** and **MUST NOT** be used for cooking.

Place the Intrigue on a flat and stable surface in an outdoor location such as a patio or deck. **DO NOT** locate the appliance where it will get excessively wet or submerged in water.



### A. Design and Installation Considerations



When planning an appliance installation, it's necessary to determine the following information before installing:



- Where will the appliance be installed? **See section 2**



#### Important:

- In compliance with UL standards, this appliance requires 24" of clearance to combustibles directly above the unit.
- Zero clearance on all sides of venturi top and mounting surface is acceptable.
- Carefully remove all burner components from packaging.
- Read all instructions before beginning installation. Follow these instructions carefully during installation to ensure maximum safety and benefit.



 <b>WARNING</b> 
<b>Fire Risk</b> Provide adequate clearance: <ul style="list-style-type: none"><li>• Around air openings.</li><li>• For service access.</li></ul> 



 <b>WARNING</b> 
<b>Asphyxiation Risk</b> <ul style="list-style-type: none"><li>• This gas appliance is for outdoor use in a well-ventilated space.</li></ul>

 <b>WARNING</b> 
Do <b>NOT</b> use this appliance if any part of it has been underwater. Have a qualified service technician inspect the appliance and replace any part of the control system and any gas control which has been underwater.

 <b>WARNING</b> 
Do not burn solid fuels in this gas appliance

### B. Inspect the Appliance and Components

 <b>WARNING</b> 
Inspect appliance and components for damage. Damaged parts may impair safe operation. <ul style="list-style-type: none"><li>A. Do <b>NOT</b> install damaged, incomplete, or substitute components</li></ul> Report damaged parts to your dealer.

 <b>WARNING</b> 
 The Outdoor GreatRoom Company disclaims any responsibility for, and the warranty will be voided by, the following actions: <ul style="list-style-type: none"><li>A. Installation and use of any damaged components.</li><li>B. Modification of the burner assembly</li><li>C. Installation other than as instructed by the Outdoor GreatRoom Company.</li></ul> <b>Any such action may cause a fire hazard</b>

# 3 Fuel Information

## A. Fuel Type

Before making gas connections, ensure that the appliance being installed is compatible with the available gas type. **This unit operates on 1lb propane tanks only.**

## B. Gas Connection

A small amount of air will be in the gas supply lines. When first lighting the appliance, it will take a short time for air to purge from the lines. Subsequent lighting of unit will not require such purging.





Storage of this appliance indoors is permissible only if it has been disconnected from its fuel supply

The specific size and capacity of the cylinder(s) to be used:

**INTRIGUE EZ: 1lb screw-on cylinder**

## C. LP Gas Supply

1. The pressure regulator supplied must be used.
2. The LP gas supply cylinder used with LP models must be constructed and marked in accordance with the specifications for LP gas cylinders of the U.S. Department of Transportation (DOT).
3. Cylinders must be stored outdoors in a well-ventilated area out of the reach of children. Disconnected cylinders must have threaded valve plugs tightly installed and must not be stored in a building, garage, or any other enclosed area.

	<b>WARNING</b>	
<b>CHECK FOR GAS LEAKS</b>		
<b>Fire Risk</b>		
<b>Explosion Risk</b>		
<b>Asphyxiation Risk</b>		
<ul style="list-style-type: none"><li>• Check all fittings and connections.</li><li>• Do not use open flame to check for leaks.</li><li>• After the gas cylinder installation is complete, all connections must be tightened and checked for leaks with a commercially available, non-corrosive leak-check solution. Be sure to rinse off all leak check solution following testing.</li></ul>		
Fittings and connections may have loosened during shipping and handling.		

# 4 Setting up the Intrigue

## Before setting up the Intrigue:

Make sure the table or mounting surface chosen contains a hole 1-1/2" or larger in diameter for proper clearance and installation.

## A. Burner Assembly - Before you begin-

1. Check for damage. Do not use damaged components.
2. If it is evident that the burner is damaged, the burner must be replaced prior to the appliance being put into operation. Use only the replacement burner assembly specified by the manufacturer.
3. Position the assembly in the desired location. You must have easy access to the on/off switch included with this product.

**Before installing the Intrigue EZ, ensure that the space below your table is large enough to accommodate the base of the unit. Some tables may have tighter leg spacing and require removing the tabletop or legs for installation and reinstalling them after the unit is in place. See below for dimensions of the installed Intrigue EZ.**

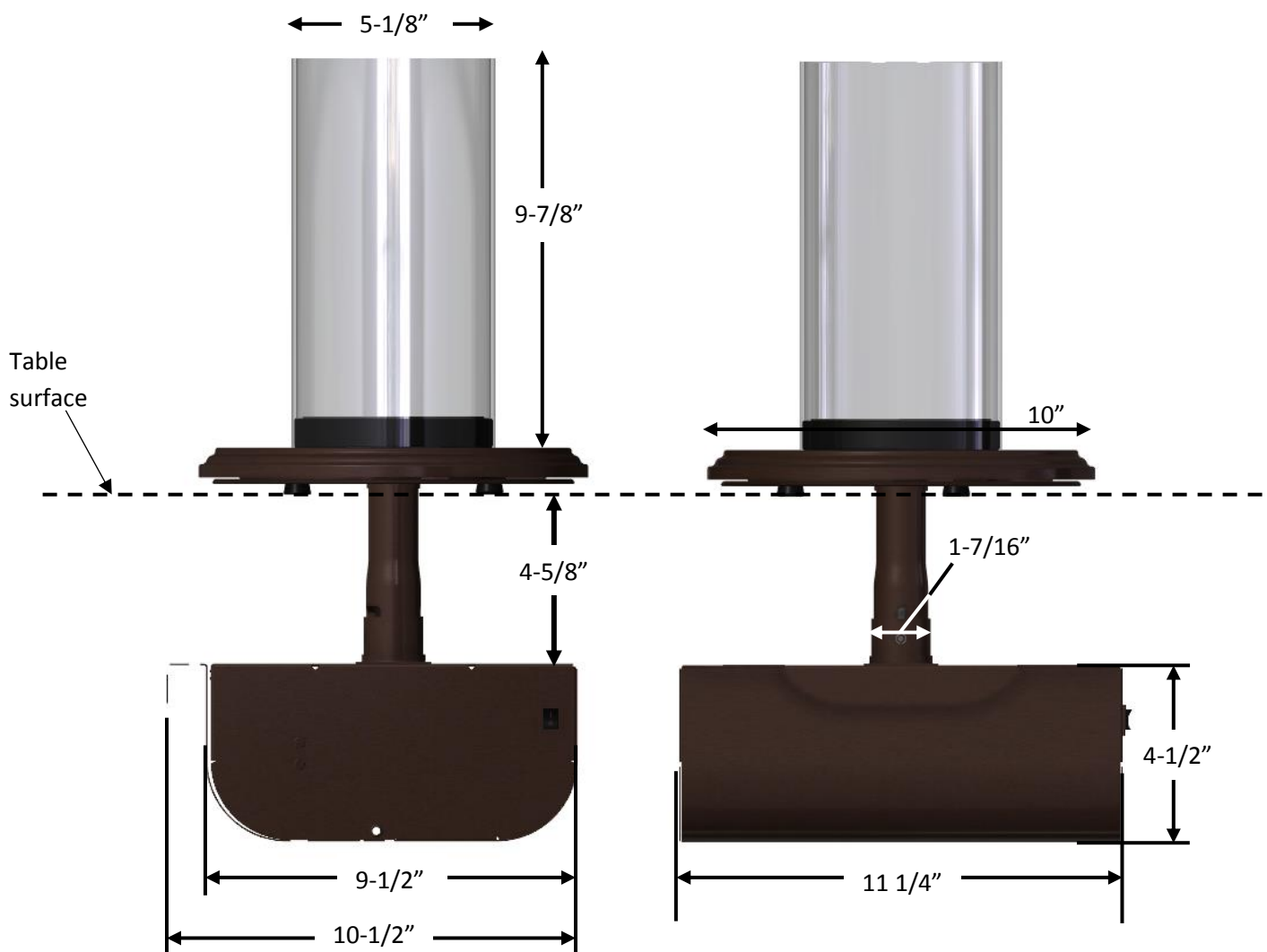



## Step 1:

Set the **Top Assembly** into the hole in your table surface. Hole must be at least 1-1/2" in diameter but no larger than 4"



## Step 2:

Insert 2 D-cell batteries into the battery compartment as shown.

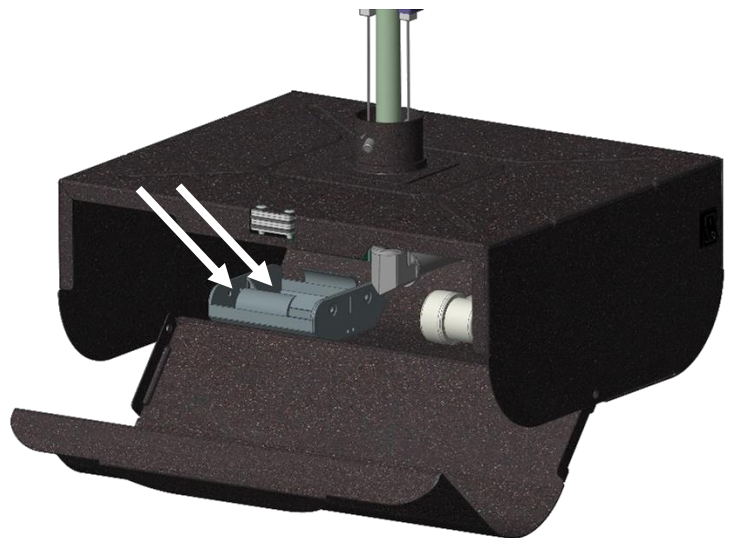
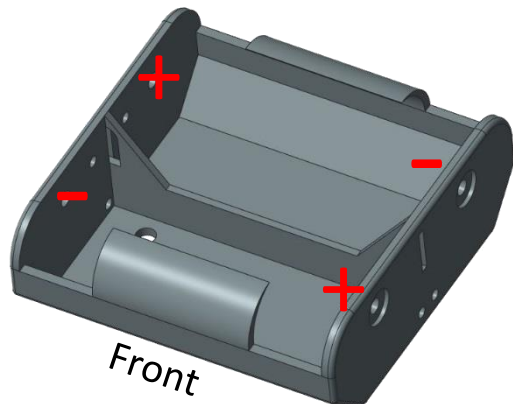

## Step 3:

Locate the two pins and slide the base of the unit up into the top, rotate to lock in place. The unit is secure when the pins drop into the holes in the tube above.

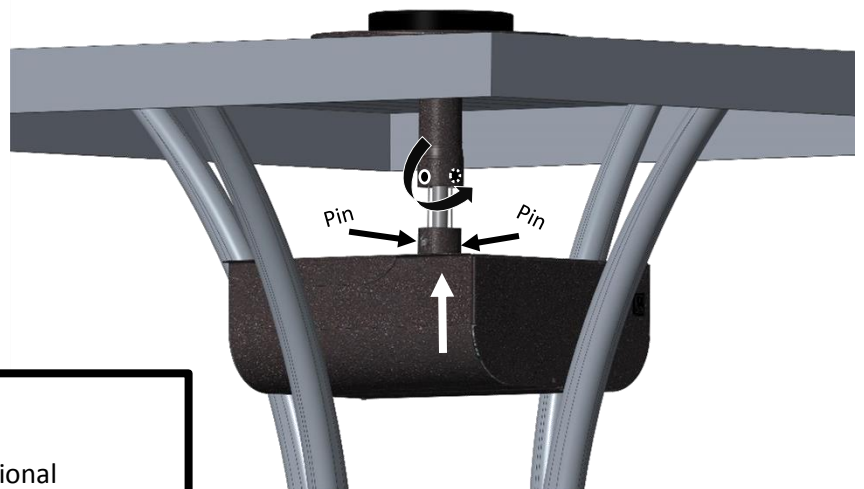

### Pro tip:

Table designs and construction vary. Additional installation steps relating to your specific table may be required. Try starting with the base upside down and rotating it into place, or carefully removing your tabletop and replacing it once the base is in place. Lifting the top assembly out of position may also help give you additional room for installation.

## Step 4:

Wearing clean, soft leather gloves, carefully press the **10" Glass Cylinder** into place until it gently contacts the metal base and sits flat and level. If the glass doesn't slide on easily, use a small amount of water (See fig. 1) to make the process easier.

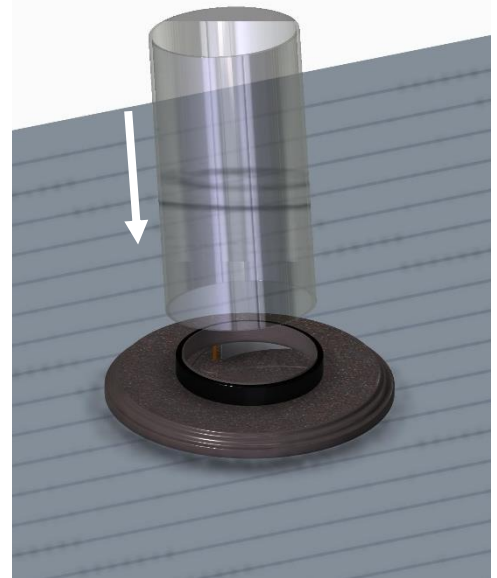
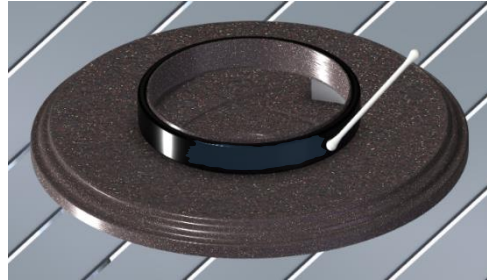

## Step 5:

Ensuring the external power switch is in the OFF "O" position, install a 1-pound propane tank as shown. Ensure that it threads into the adapter easily and smoothly to avoid damage to the tank or tank adapter.

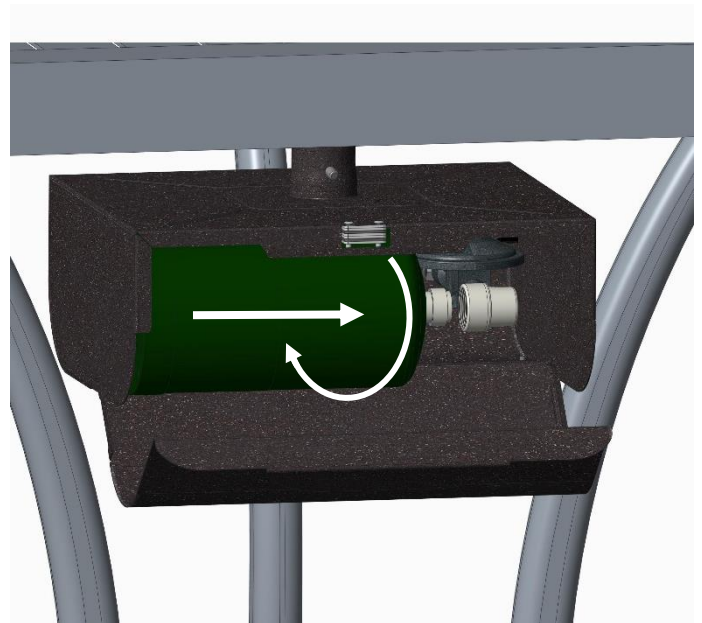

## Step 6: Enjoying your Intrigue EZ

Flip the external power switch to the ON "I" Position to ignite. When finished using, flip the switch to the OFF "O" position to extinguish.

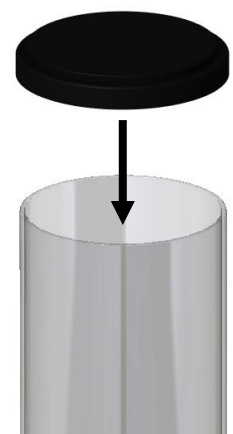

Included silicone cover can be placed on top of glass to protect burner and aid in storage.

**REMOVE** silicone cover before each use.



**SEE NEXT PAGE FOR IMPORANT SAFETY INFORMATION**

## B. Important warnings and safety information

 **WARNING** 



**Fire Risk**  
**Burn Risk**  
**HOT! DO NOT TOUCH.**   
**SEVERE BURNS MAY RESULT.**  
**CLOTHING IGNITION MAY RESULT.**

Glass and other surfaces are hot during operation and cool-down.

- Children and adults should be alerted to the hazards of high surface temperatures and should stay away to avoid burns or clothing ignition.
- Young children should be carefully supervised when they are in the area of the appliance
- Installation and repair should be done by a qualified service person. The appliance should be inspected before use and at least annually by a qualified service person. More frequent cleaning may be required as necessary. It is imperative that control valve, burner, and air passageways in venturi top be kept clean.



 **WARNING** 

Improper installation, adjustment, alteration, service, or maintenance can cause injury, property damage, or death. For assistance or additional information consult a qualified installer, service agency, or the gas supplier.

 **WARNING** 

**Fire Risk** 

When transporting intrigue to a new location, you must remove fuel source and batteries to ensure appliance does not light or attempt ignition.

 **WARNING** 

**Fire Risk**  
**High Temperatures** 

Keep combustible household items away from appliance.

- Do NOT obstruct combustion and ventilation air.
- Do NOT place combustible items on top of or near appliance.
- Keep furniture, draperies away from appliance.
- Do NOT use gasoline, lantern fuel, kerosene, charcoal lighter fluid, or similar liquids in this appliance.
- Combustible materials, flammable liquids, or vapors may ignite.

 **WARNING:** This product can expose you to chemicals including Carbon Monoxide and Benzene which are known to the State of California to cause cancer or birth defects or reproductive harm. For more information, visit [www.P65Warnings.ca.gov](http://www.P65Warnings.ca.gov)

# 5 Operating your Intrigue

## FOR YOUR SAFETY, READ BEFORE LIGHTING

### WARNING!

If you do not follow these instructions exactly, a fire or explosion may result causing property damage, personal injury, and/or loss of life.

- A. This appliance must be lit electronically. When lighting, follow these instructions exactly.
- B. **Before lighting**, smell all around the appliance area for gas. Be sure to smell next to the base of the appliance because some gas is heavier than air and will settle on the floor.
- C. Do not use the appliance if any part has been underwater. Immediately call a qualified service technician to inspect the appliance and replace any part which has been underwater.
- D. The gas pressure regulator provided with this appliance must be used. This regulator is set for an outlet pressure of 10.5 inches water column.

### WHAT TO DO IF YOU SMELL GAS:

- Do not try to light any appliance.
- Do not touch any electric switch, do not use any phone nearby.
- Immediately call your gas supplier from a neighbor's phone. Follow gas supplier's instructions.
- If you cannot reach your gas supplier, call the fire department

## Lighting Instructions

### Electronic Ignition

1. **STOP!** Read the safety information above.
2. Locate two-position switch and set to ON position (I)
3. Burner should begin sparking.
  - During first use, it may take longer than usual for flame to ignite due to air being present in gas line. This is normal.
  - If sparking stops before flame ignites, turn the unit to the OFF position (O) and consult troubleshooting section of this manual (P.15)
4. **To extinguish, put switch in OFF position.**

#### NOTE:

This device contains an intelligent flame recognition system which will produce a spark until the presence of a flame is detected. Ensure that burner area and sensing/igniting electrodes are kept clear for proper operation. The burner will go into safety shut-off mode in excessive wind or rain. This mode requires the unit to be reset before it will operate again. To reset, simply switch the unit off and then back on again to resume operation.

# 6 Troubleshooting



With proper installation, operation, and maintenance, your Intrigue will provide years of trouble-free service. If you do experience a problem, this troubleshooting guide will assist a qualified service person in the diagnosis of a problem and the corrective action to be taken. This troubleshooting guide should only be used by a qualified service technician.





Symptom	Possible Causes	Corrective Actions
Igniter sparks but will not light	Tank may be empty	Replace the tank with a full one
	Spark may not be occurring from burner area	Ensure wires are not shorted or pinched. Replace bad wires and check connections.
Unit ignites but will not stay lit, or spark continues after ignition	Sensing rod may not be near enough to flame	Relocate sensing rod (orange wire) into flame
	Sensing rod may be blocked by debris	Clean burner and sensing electrode (orange wire)
	Glass may not be installed correctly	Re-seat glass on gasket snugly
	Burner may be wet	Dry burner and check ports for water
Burner ignites and self-extinguishes	The unit may have low batteries (Or one of the above issues)	Replace batteries
	Excessive rain or wind	In excessive rain or wind, the unit may fail to sense flame or safely operate. Try again when conditions improve
No spark is present when attempting to ignite	Batteries not installed or batteries may be dead	Replace batteries
	Switch wiring may be damaged or disconnected	Check wiring for damage. Replace wiring if needed.

# 7 Service and Maintenance

Although the frequency of appliance servicing and maintenance will depend on the use and type of installation, a qualified service technician should perform an appliance checkup annually.

Storage of an appliance indoors is permissible only if the cylinder is disconnected and removed from the appliance.

 <b>WARNING</b> 
<b>Risk of injury or property damage</b>
<b>Before servicing:</b>
<ul style="list-style-type: none"> <li>• Turn off utilities to appliance.</li> <li>• Ensure the appliance is completely cooled.</li> </ul>

 <b>WARNING</b> 	
	<p>Annual inspection by a qualified technician is recommended.</p> <p><b>Check:</b></p> <ul style="list-style-type: none"> <li>• Obstructions of combustion and ventilation air.</li> <li>• Condition of burner assembly.</li> <li>• Burner ignition and operation.</li> <li>• Gas connections and fittings.</li> </ul>
	<p><b>Risk of:</b></p> <ul style="list-style-type: none"> <li>• Fire</li> <li>• Delayed ignition or explosion</li> <li>• Exposure to combustion fumes</li> <li>• Odors</li> </ul>
	

Inspect	Maintenance Tasks
Glass	<ul style="list-style-type: none"> <li>• Inspect glass for cracks or chips</li> <li>• Carefully remove glass and clean</li> </ul>
Venturi Disc	<ul style="list-style-type: none"> <li>• With glass removed, inspect venturi disc for debris or damage.</li> <li>• Clean disc using a soft rag and non-abrasive cleaner</li> </ul>
Burner Assembly	<ul style="list-style-type: none"> <li>• Inspect for damage or debris.</li> <li>• Carefully wipe down surface being careful not to bend or break electrodes</li> </ul>
Valve and igniter assembly	<ul style="list-style-type: none"> <li>• Inspect for damaged or disconnected wires</li> <li>• Ensure correct operation of ignition system</li> <li>• Check for gas leaks and tighten connections</li> </ul>

# 8 Reference Materials

Part description	Part Number	QTY
10" Glass cylinder	INTRIGUE-GLASS	1
Top Assembly	INTRIGUE-VFTOP	1
Battery Pack	BATTERY-PACK	1
Control Module	INTRIGUE-MODULE	1
Control Switch	INTRIGUE-SWITCH	1
Glass Cover	INTRIGUE-GLASS COVER	1



The Outdoor Greatroom Company  
14400 Southcross Dr W Suite 100  
Burnsville, MN 55306

[www.outdoorrooms.com](http://www.outdoorrooms.com)

Please contact your Outdoor Greatroom Company  
dealer  
with any questions or concerns. For the number of  
your nearest Outdoor Greatroom dealer, please call  
866.303.4028.

- NOTES -

---

---

---

---

---

## 9 Limited 1-year Warranty



The Outdoor GreatRoom Company extends the following warranty for Outdoor GreatRoom outdoor products used in the United States of America or Canada. Dealers and employees of The Outdoor GreatRoom Company have no authority to make any warranty or authorize any remedies in addition to or inconsistent with the terms of this warranty. This warranty gives you specific legal rights. You may also have other rights that vary from state to state.

The Outdoor GreatRoom Company warrants that this Outdoor GreatRoom Outdoor Product (the "Product") will be free from defects in material and workmanship for a period of one year from its date of purchase. Stainless steel parts and assemblies carry a limited lifetime warranty. This warranty is subject to the conditions, exclusions and limitations described below.

This warranty applies only to the original owner of the Product and is non-transferable. The Outdoor GreatRoom Company obligation under this warranty does not extend to damages resulting from (1) assembly, operation or maintenance of the Product not in accordance with the Installation/Assembly Instructions, Operating Instructions and the Listing Agency Identification Label furnished with the Product; (2) installation or use which does not comply with local building codes and ordinances; (3) shipping, improper handling, improper operation, abuse, misuse, accident or unworkmanlike repairs; (4) use of fuels other than those specified in the Operating Instructions; (5) Installation or use of components not supplied with the Product or any other components not expressly authorized and approved in writing by The Outdoor GreatRoom Company; and/or (6) modification of the Product not expressly authorized and approved in writing by The Outdoor GreatRoom Company. Any of the circumstances described in the previous sentence voids this warranty. This warranty is void if the Product or any component has been removed, repaired, or replaced before The Outdoor GreatRoom Company has been afforded a reasonable opportunity to inspect the Product.

This warranty is limited to the replacement or repair of defective components or workmanship and The Outdoor GreatRoom Company may fully discharge its obligations under this warranty by repairing or replacing, at its discretion, the defective components. The Outdoor GreatRoom Company will provide replacement parts at no charge and will pay reasonable and necessary labor and freight costs related to replacing or repairing defective components under this warranty. The maximum amount recoverable under this warranty is limited to the purchase price of the Product and, if The Outdoor GreatRoom Company is unable to provide replacement or repair in an expedient and cost-effective manner, The Outdoor GreatRoom Company may discharge all obligations under this warranty by refunding the purchase price of the Product.

EXCEPT TO THE EXTENT PROVIDED BY LAW, THE OUTDOOR GREATROOM COMPANY MAKES NO EXPRESS WARRANTIES OTHER THAN THE WARRANTY EXPRESSED HEREIN. THE DURATION OF ANY IMPLIED WARRANTY IS LIMITED TO THE DURATION OF THE WARRANTY SPECIFIED ABOVE. IN NO EVENT SHALL THE OUTDOOR GREATROOM COMPANY BE LIABLE FOR ANY INCIDENTAL OR CONSEQUENTIAL DAMAGES CAUSED BY DEFECTS IN THE PRODUCT. Some states do not allow limitations on how long an implied warranty lasts, or do not allow exclusion or limitation of incidental or consequential damages, so these limitations may not apply to you.

**To obtain service under this warranty, you must:**

1. Send written notice of the claimed condition to: The Outdoor GreatRoom Company, 14400 Southcross Dr W Suite 100, Burnsville, MN 55306.
2. Affirm that you are the original owner of the Product.
3. Provide The Outdoor GreatRoom Company reasonable opportunity to investigate the claim, including reasonable opportunity to inspect the Product prior to any repair or replacement work and before the Product or any component of the Product has been removed.